

⑧	Fixed Plate	—	1	Stainless Steel	—	—
⑦	Revolving Wheel	—	1	NYLON	Black	—
⑥	Contact	—	1	Phosphor bronze	—	—
⑤	Base	—	1	NYLON	Black	—
④	Shell	—	1	Iron	Plating Silver	—
③	Terminal	3	1	Brass(0.2t)	Plating Silver	—
②	Terminal	2	1	Brass(0.2t)	Plating Silver	—
①	Terminal	1	1	Brass(0.2t)	Plating Silver	—
ITEM	PART NAME	TER'NO.	QTY.	MATERIAL	FINISHING	REMARK

Rating	5VDC 1mA
Contact Resistance	500mΩ Max
Insulation Resistance	50MΩ Min
Dielectric Voltage	250VAC 60±5S
Endurance	100,000 cycles
Rotational Force	15-30gf.cm

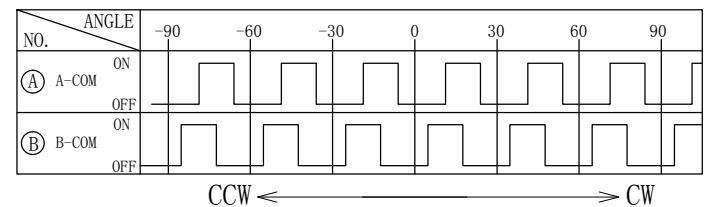
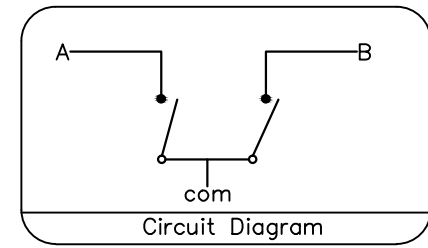

Numbers of detent: 12
Pulse/Rotation: 12 Pulse/360° (reverse)

Shaft hole shape and dimension

Shaft hole position will be at random

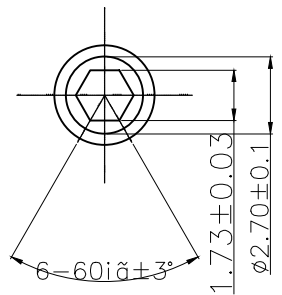

(Tolerance: ±0.1)
(P.C.B thickness t=1.6mm)

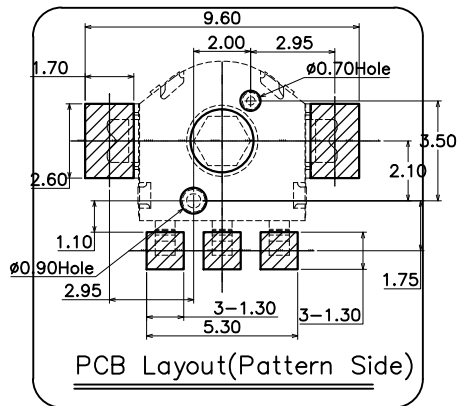

备注：底座背面的压针孔 ○ 是根据产品模具成型要求而定的，其规格的大小与数量的多少对产品结构、功能及使用无任何影响。