

SCHEMATIC

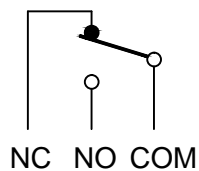

ITEM	PART NAME	MATERIAL	COLOR
1	CONTACT	Ag Alloy	
2	MOVABLE PLATE	TITANIUM COPPER	
3	BUTTON	POM	WHITE
4	COVER	PBT	BLACK
5	BASE	PPA	WHITE
6	TERMINAL	SILVER PLATE BRASS	

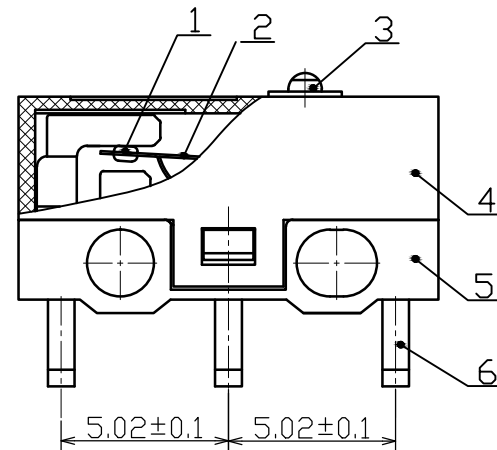

Rating	5VDC 100mA
Contact Resistance	100mΩ Max
Insulation Resistance	50MΩ Min
Dielectric Voltage	250VAC 60±5S
Endurance	3,000,000 cycles
Operating Force	60±10gf
Pre-travel	0.35±0.15mm